

FASTENING SYSTEMS

SISTEMAS DE SUJECIÓN SYSTEMES DE SERRAGE

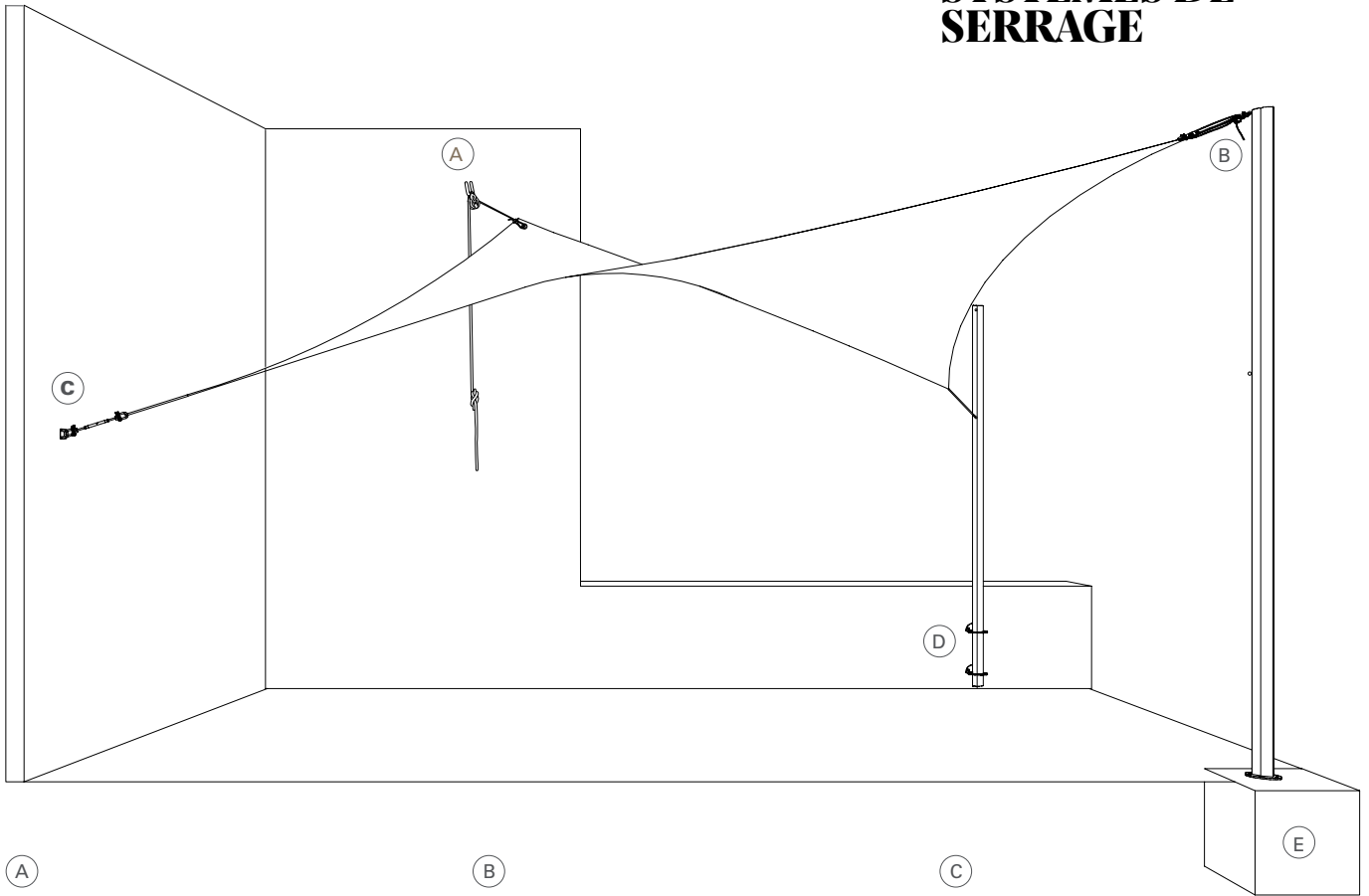

A

FASTENING BY SIMPLE TENSION SYSTEM
SUJECIÓN MEDIANTE SISTEMA DE TENSIÓN SIMPLE
SERRAGE PAR UN SYSTÈME DE TENSION SIMPLE

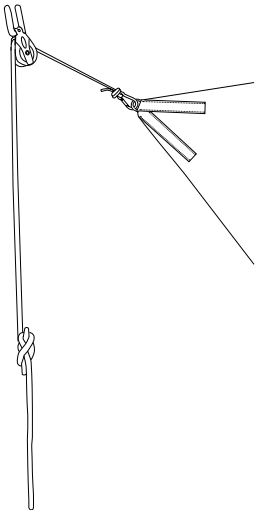

B

SUPPORTING THROUGH TENSION SYSTEM WITH DEMULTIPLICATION
SUJECIÓN MEDIANTE SISTEMA DE TENSIÓN CON DEMULTIPLICACIÓN
LA MISE EN TENSION PAR UN SYSTÈME DE DÉMULTIPLICATION

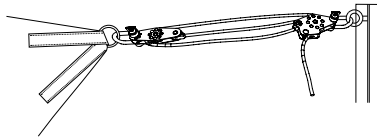

D

MAST WITH WALL FASTENING
MÁSTIL CON SUJECIÓN A MURO
MÂT AVEC FIXATION AU MUR

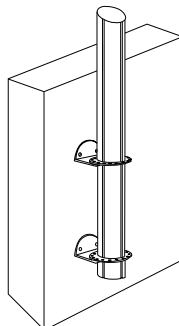

C

FASTENING THROUGH TENSION SYSTEM WITH FIXED TENSIONER
SUJECIÓN MEDIANTE SISTEMA DE TENSIÓN CON TENSOR FIJO
SERRAGE PAR UN SYSTÈME DE TENSION AVEC TENDEUR DE CÂBLE

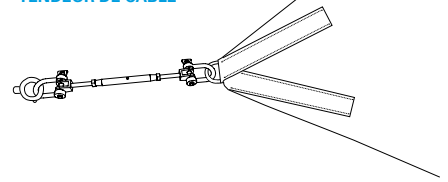

E

MAST WITH FLOOR SUPPORT
MÁSTIL CON SUJECIÓN AL SUELO
MÂT AVEC FIXATION AU SOL

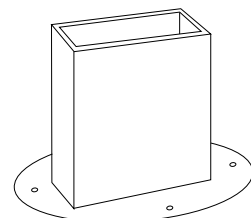

FASTENING BY SIMPLE TENSION SYSTEM

Support system to carry the sail hold to any point by means of a pulley.

It consists of a carabiner that goes to a sail attached to a rope, a pulley that is placed at any point by means of a bridge and a shackle and a lower cleat to withstand the tension.

SUJECCIÓN MEDIANTE SISTEMA DE TENSIÓN SIMPLE

Sistema de sustentación para llevar la sujeción de la vela a cualquier punto mediante una polea.

Se compone de una polea sujeta a un puente mediante un grillete, un cabo con un mosquetón y una conamusa.

SERRAGE PAR UN SYSTÈME DE TENSION SIMPLE

Système de tension permettant de maintenir la voile en tout point par une poulie.

Il se compose d'une poulie fixée à un pont par une manille, d'une ligne avec un mousqueton et d'un taquet.

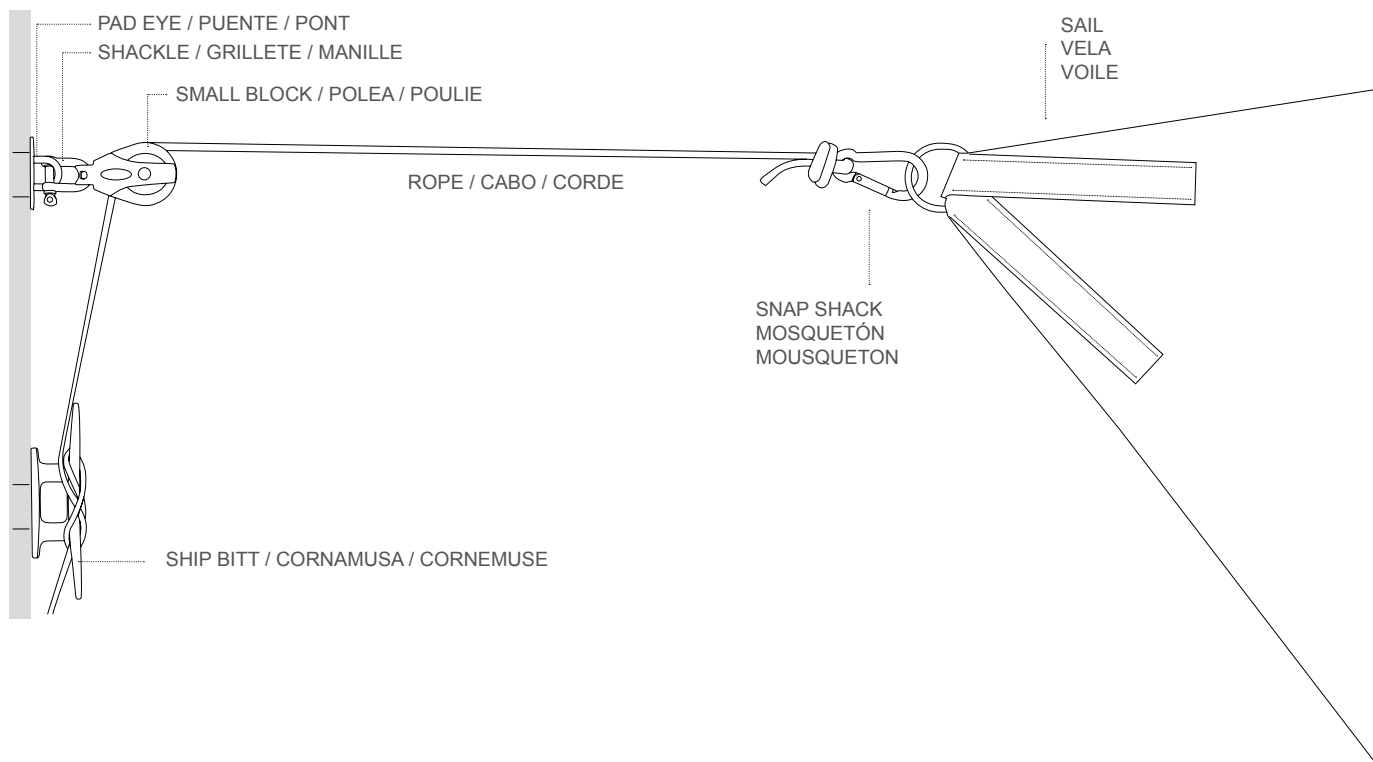

PIECES / PIEZAS / PIECES

- Small Block / Polea / Poulie
- Rope / Cabo / Cap
- Pad eye / Puente / Pont
- Shackle / Grillete / Manille
- Snap shack / Mosquetón / Mousqueton
- Ship bitt / Cornamusa / Taquet

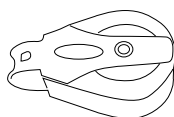

SMALL BLOCK
POLEA
POULIE

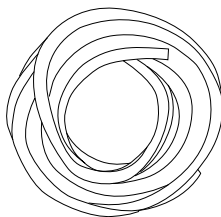

ROPE
CABO
CAP



PAD EYE
PUENTE
PONT



SHACKLE
GRILLETE
MANILLE

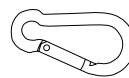

SNAP SHACK
MOSQUETÓN
MOUSQUETON



SHIP BITT
CORNAMUSA
TAQUET

SUPPORTING THROUGH TENSION SYSTEM WITH DEMULTIPLICATION

The reduction allows us to multiply by three the force exerted when pulling the rope.

This system consists of a pulley with lashing attached to an eyebolt by means of a shackle and a double pulley attached to the sail by means of a shackle.

SUJECCIÓN MEDIANTE SISTEMA DE TENSIÓN CON DESMULTIPLICACIÓN

La desmultiplicación nos permite multiplicar por tres la fuerza realizada al tirar del cabo.

Este sistema se compone una polea con trinca sujeta a un cáncamo mediante un grillete y una polea doble sujeta a la vela mediante un grillete.

LA MISE EN TENSION PAR UN SYSTÈME DE MISE EN TENSION AVEC DÉMULTIPLICATION

Le système de réduction par engrenage nous permet de multiplier par trois la force produite lors de la traction de la corde.

Ce système est composé d'une poulie à cliquet fixée à un œillet au moyen d'une manille et d'une poulie double fixée à la voile au moyen d'une manille.

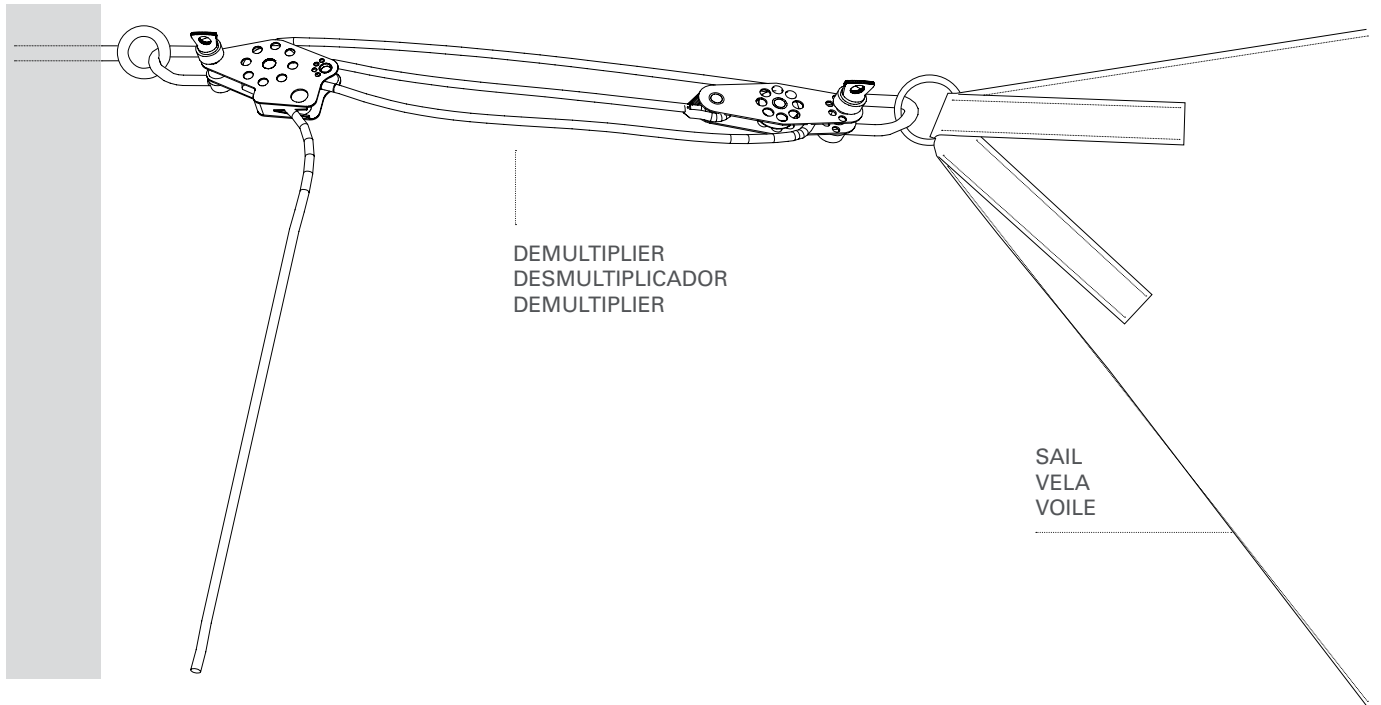

PIECES / PIEZAS / PIECES

- Eyebolt / Cáncamo / Anneau à visser
- Placa con anilla / Placa con anilla / Placa con anilla
- Polea con arraigo / Polea con arraigo / Polea con arraigo
- Polea violón con trinca / Polea violón con trinca / Polea violón con trinca
- Shackles / Grilletes / Manilles



EYEBOLT
CÁNCAMO
ANNEAU À
VISSER

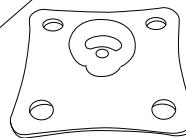
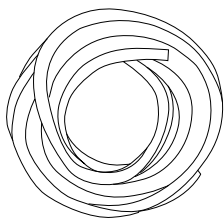

PLATE WITH RING
PLACA
CON ANILLA
ASSIETTE AVEC ANNEAU



ROPE
CABO
CORDE



POLEA VIOLIN CON ARRAIGO
POLEA VIOLIN CON ARRAIGO
POLEA VIOLIN CON ARRAIGO

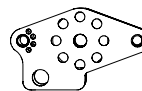

POLEA VIOLIN CONTRINCA
POLEA VIOLIN CONTRINCA
POLEA VIOLIN CONTRINCA

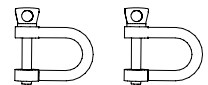

SHACKLES
GRILLETES
MANILLES

FASTENING THROUGH TENSION SYSTEM WITH FIXED TENSIONER

It is made up of a tensioner attached to an eyebolt by means of a shackle and to the sail by another. Allows you to modify the length of the clamp 10 cms.

SUJECCIÓN MEDIANTE SISTEMA DE TENSIÓN CONTENSOR FIJO

Se componme de un tensor sujeto a un cáncamo mediante un grillete y a la vela mediante otro. Permite modificar la longitud de la sujeción 10 cms.

FERMETURE À TENDEUR FIXE

Il se compose d'un tendeur fixé à un boulon à œil au moyen d'une manille et à la voile au moyen d'une autre manille. Il permet de modifier la longueur de la fixation de 10 cm.

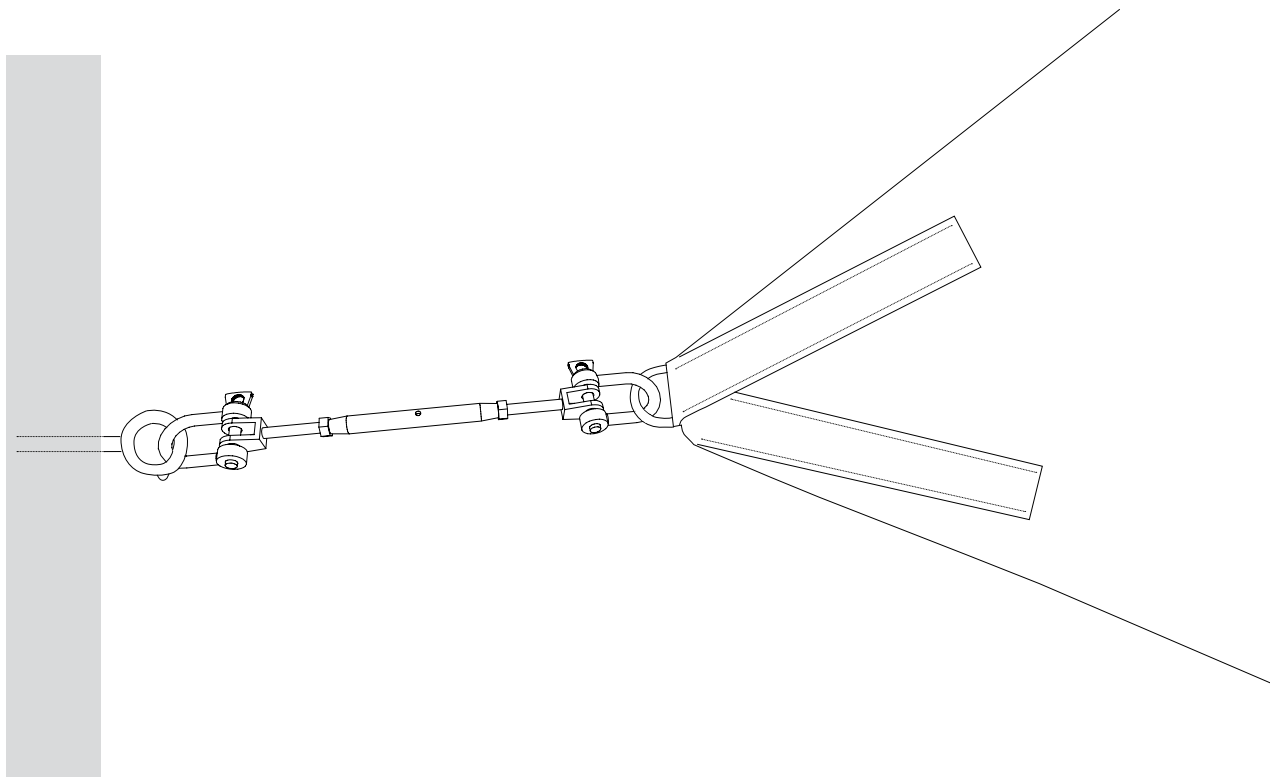

PIECES / PIEZAS / PIECES

- Eyebolt / Cáncamo / Anneau à visser
- Placa con anilla / Placa con anilla / Plaque avec anneau
- Shackles / Grilletes / Manilles
- Tensor / Tensor / Tendeur



EYEBOLT
CÁNCAMO
ANNEAU À
VISSER

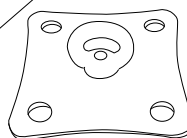
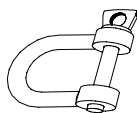
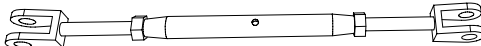

PLATE WITH RING PLACA
CON ANILLA
PLAQUE AVEC GOUPILLE



SHACKLE
GRILLETE
MANILLE



TENSOR INOX
TENSOR
TENDEUR

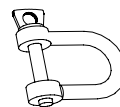

SHACKLE
GRILLETE
MANILLE